



Rotary Screw Compressors

HSD Series

With the world-renowned SIGMA PROFILE

Flow rate 8 to 89 m³/min, Pressure 5.5 to 15 bar

HSD series

With the power of two airends

Every water-cooled HSD series rotary screw compressor comprises two compressor units, each of which operates and is controlled independently from the other. System availability is also optimised, which means that performance can be precisely adjusted to suit requirement and costly idling can be kept to an absolute minimum.

KAESER's meticulous attention to detail, such as large double doors to assure excellent component accessibility, external air intake via openings in the roof hood and the use of two large internal fans for optimised cooling performance, ensures user-friendly operation and exceptional ease of maintenance.

Integrated energy savings

The impressive energy efficiency results from the improved specific performance of the further refined SIGMA PROFILE screw airend rotors. In addition, high efficiency IE4 motors provide loss-free 1:1 direct power transmission to the compressor airend. The SIGMA CONTROL 2 compressor controller's master-slave function also allows compressor performance to be efficiently adjusted according to actual compressed air demand. Therefore, with selectable control options and through minimised (costly) idling periods, for example, it is possible to save even more energy.

Service-friendly = Efficient

Successful package design goes far beyond external appearance: it's what's on the inside that truly counts, especially when it comes improving efficiency. For example, the fluid separator cartridges can be easily replaced from the top of the package once the roof hood on the outside left-hand side has been lifted up. This not only saves time (and money), but also increases compressor availability.

Perfect team player

HSD series rotary screw compressors are perfect for high-efficiency industrial compressed air stations. Various interfaces of both internal SIGMA CONTROL 2 compressor controllers enable easy, secure and efficient networking in the KAESER SIGMA NETWORK with the Industrie 4.0-capable SIGMA AIR MANAGER 4.0 management system and/or other centralised control systems.

Stay cool with ETM

Powered via an electric motor, the sensor-controlled temperature control valve integrated into the cooling circuit is the heart of the innovative Electronic Thermo Management (ETM) system. The SIGMA CONTROL 2 monitors intake and compressor temperatures in order to safely prevent condensate formation, even under conditions with higher air humidity. The ETM dynamically controls the fluid temperature, and low fluid temperature enhances energy efficiency. If heat recovery is used, this can be adjusted to better meet the customer's requirements thanks to two additional ETMs.

Why choose heat recovery?

The question should in fact be: Why not? Amazingly, up to 100 % of the (electrical) energy input to a compressor is converted into heat. Up to 96 % of this energy can be recovered and reused for heating purposes. This not only reduces primary energy consumption, but also significantly improves the company's total energy balance.

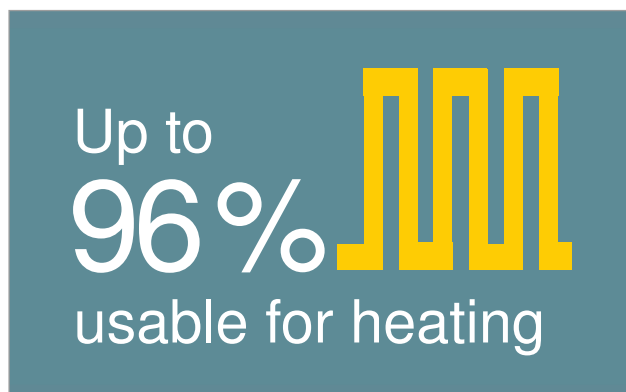

Up to
96%
usable for heating

The infographic features a dark teal background. On the right side, there is a stylized yellow graphic of three vertical bars of varying heights, resembling a bar chart or a simplified representation of a compressor's internal structure. To the left of this graphic, the text 'Up to 96%' is written in a large, white, sans-serif font, with '96%' being significantly larger than 'Up to'. Below this, the text 'usable for heating' is written in a smaller, white, sans-serif font.

Energy savings through and through



Image: Water-cooled HSD 782

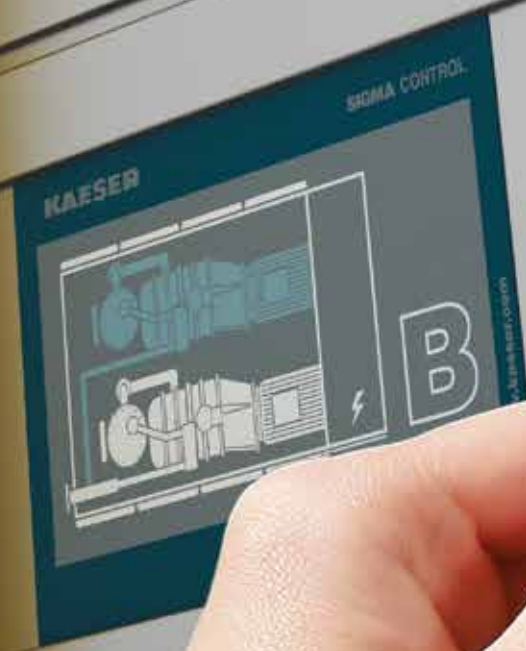
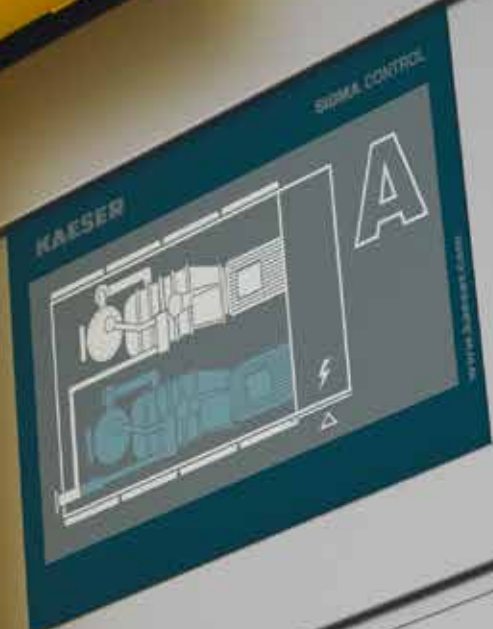

HSD series

Energy savings in every detail



Save energy with the SIGMA PROFILE

Two rotary screw airends with energy-saving SIGMA PROFILE rotors form the core of every HSD package. These high efficiency rotors are flow-optimised and play a large part in helping HSD packages set the new standard in specific power performance.



Efficiency centre: 2x SIGMA CONTROL 2

The internal SIGMA CONTROL 2 controllers guarantee efficient control and monitoring of compressor operation at all times. Clear displays and RFID readers provide easy communication and maximum security. Variable interfaces enable seamless networking capability, whilst the SD card slots make updates quick and easy.



Tomorrow's technology, today: IE4 motors

KAESER KOMPRESSOREN is currently the only compressed air systems provider to equip its compressors with super premium efficiency IE4 specification drive motors as standard, thereby ensuring maximum performance and energy efficiency.



Correct temperature assured

For every compressor unit, the innovative Electronic Thermo Management (ETM) system controls the fluid temperature to assure reliable prevention of condensate accumulation. The ETMs increase energy efficiency, e.g. by adjusting heat recovery and operational requirements.

HSD series

Twin pack: double dependability

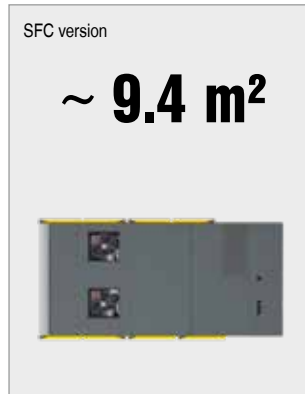
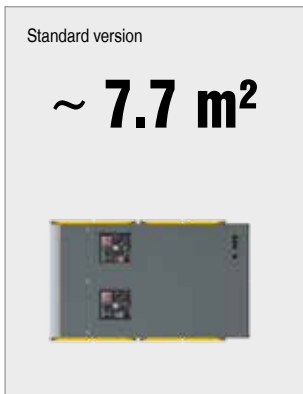

More compressor, less space requirement

Made possible using water-cooling technology, the exceptionally compact design of HSD and HSD SFC systems means that they are able to deliver maximum compressed air performance with minimal space requirement. This simplifies the planning process for compressor stations and reduces the number of required packages – even with high compressed air demand.

Quiet

Thanks to water cooling, carefully matched intake and cooling air flow and excellent soundproofing, HSD packages operate with sound levels of only 71-73 dB(A). This eliminates the need for additional work- and cost-intensive soundproofing of the compressed air station.



Double dependability and efficiency

Two complete SIGMA PROFILE compressor airends maximise safety and availability: if one airend is not operating for any reason, e.g. during servicing work, 50 percent of the total flow rate still remains available. In the master/slave mode, the SIGMA CONTROL 2 controllers adjust the base/peak load switch-over according to actual compressed air demand.



System-gentle start

The two drive motors of HSD rotary screw compressors always start one after the other with a slight delay. This results in a significantly lower load on the electricity supply network compared with a synchronous start approach.

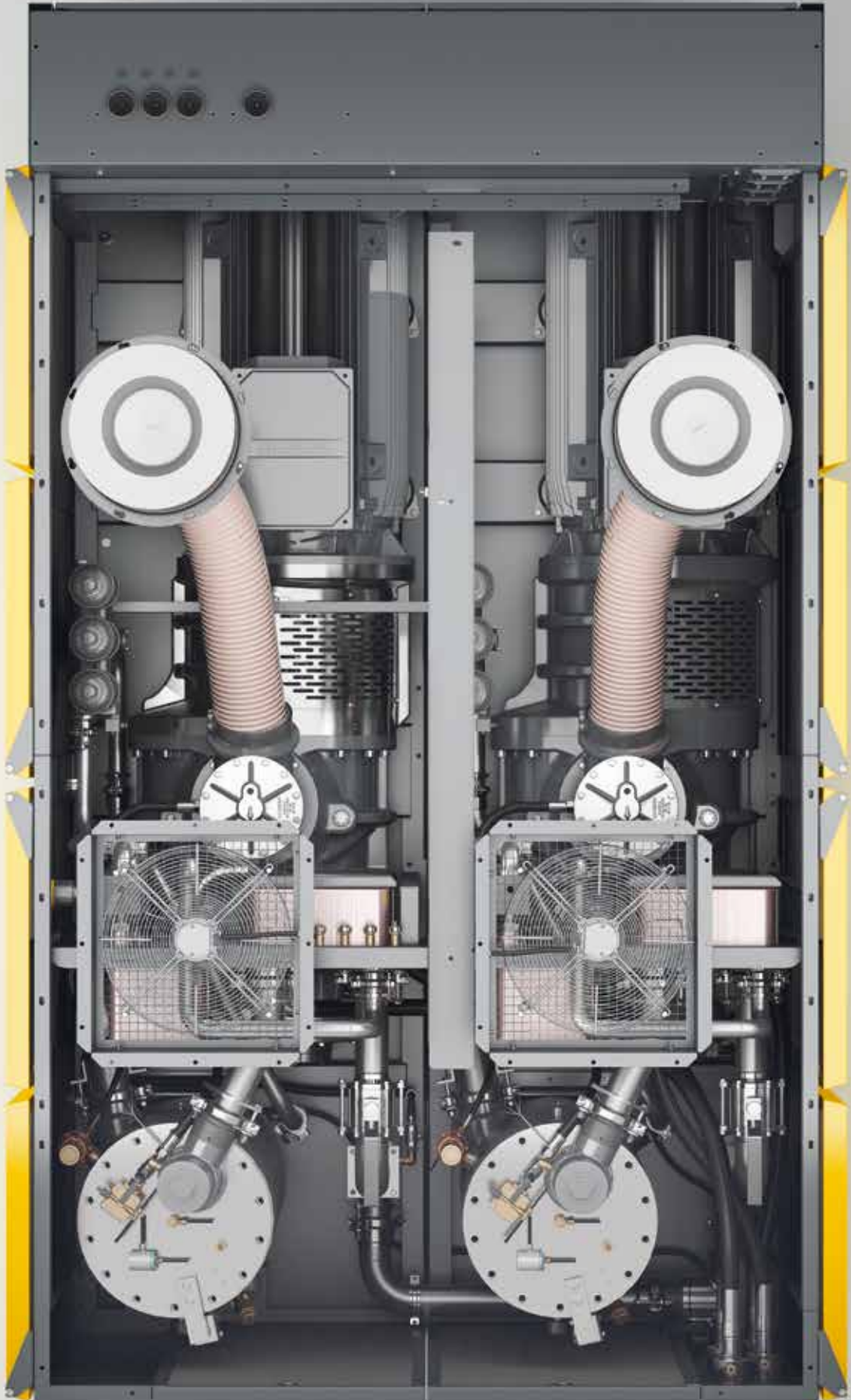

Image: HSD 782 – Twin pack



HSD series

Efficient in every detail



Redesigned inlet valve

With low inlet pressure loss, the flow-optimised inlet valve also helps achieve significant energy savings. The omission of a strong compression spring reduces the wear on gaskets and guides. It also increases safety when performing service work. Only the cover needs to be removed in order to perform maintenance work.



Dependable condensate separation

Integrated as standard, the KAESER axial centrifugal separators with electronic ECO-DRAIN condensate drains assure an exceptionally high degree of separation (>99 %) with minimal pressure loss. Even with high ambient temperatures and air humidity, condensate separation is performed reliably and efficiently.



Environmentally-friendly fluid filter

The eco-filter elements used in the aluminium fluid filter housings do not contain any metal components. They can therefore simply be disposed of thermally at the end of their service life without any further pre-treatment.

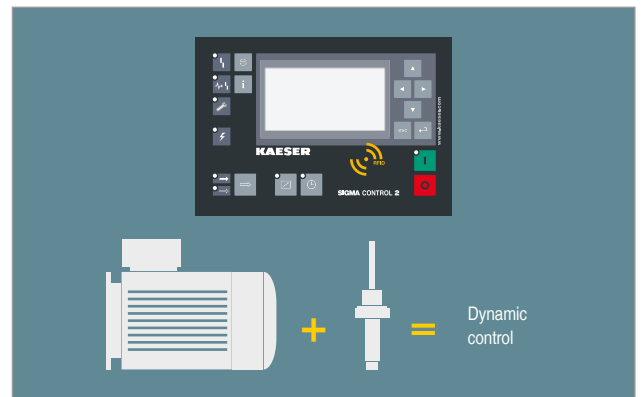

Drive motor with Pt100

The dynamic control feature calculates run-on times based on the motor winding temperature – this reduces both idling time and energy consumption. The SIGMA CONTROL 2 offers additional control modes that can be called up at any time.

Service-friendly

Excellent accessibility



Oil separator cartridge replacement

The cartridges can be replaced easily from the top, once the left, top enclosure panel has been folded up. The oil separator covers can be swivelled to the side inside the package.



External lubrication

The two electric drive motors must be lubricated while running. In HSD compressors, service personnel can easily perform this task from the outside of the machine.



Image: Water-cooled HSD 782



Monitored air intake filter

The SIGMA CONTROL 2 permanently monitors the degree of air intake filter contamination and displays the level as a percentage. This enables users to determine the date for filter replacement according to priority: operational reliability or economy.



Easy replacement of maintenance parts

Just like the air filter which is changed from the front of the unit, all other maintenance parts are easily accessible. This speeds up service work, thereby reducing operating costs and increasing availability. The pre-separator filtering mat of the air intake filter captures coarse contaminant particles.



SFCW

SFCW

Clever speed-control combination

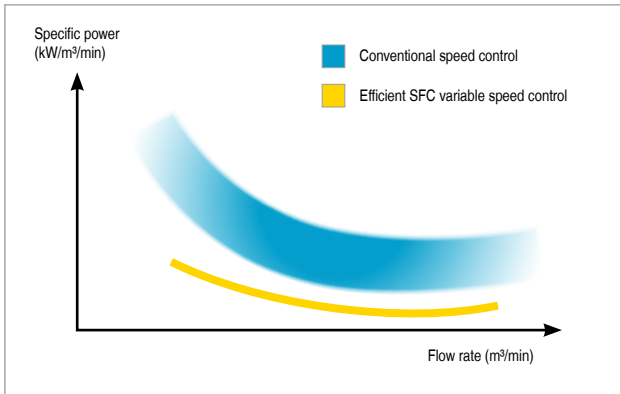

Optimised specific power

In HSD SFC packages, one of the two rotary screw compressors operates as a speed-controlled unit with the KAESER SIGMA FREQUENCY CONTROL (SFC), which is optimised to run with high efficiency and low speeds. This saves energy, maximises service life and enhances reliability.

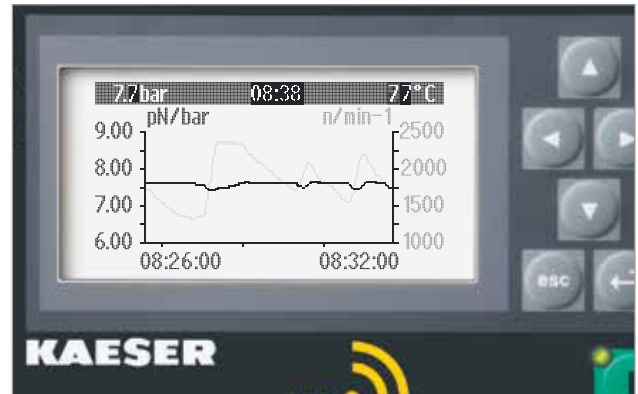

Precision pressure control

The compressed air flow rate can be adjusted within the control range according to pressure to suit actual compressed air demand. As a result, operating pressure is precisely maintained to within +/- 0.1 bar. This allows maximum pressure to be reduced which saves both energy and money.



Separate SFC control cabinet

The SFC (SIGMA FREQUENCY CONTROL) variable speed drive is housed in its own control cabinet to shield it from heat from the compressor. Its separate fan keeps operating temperatures in the optimum range to ensure maximum performance and service life from the SIGMA FREQUENCY CONTROL.



EMC-certified

It goes without saying that the SFC control cabinet and SIGMA CONTROL 2 are tested and certified both as individual components and as a complete system to EMC directive EN 55011 for Class A1 industrial power supplies.

HSD series - water-cooled...

...with plate heat exchanger

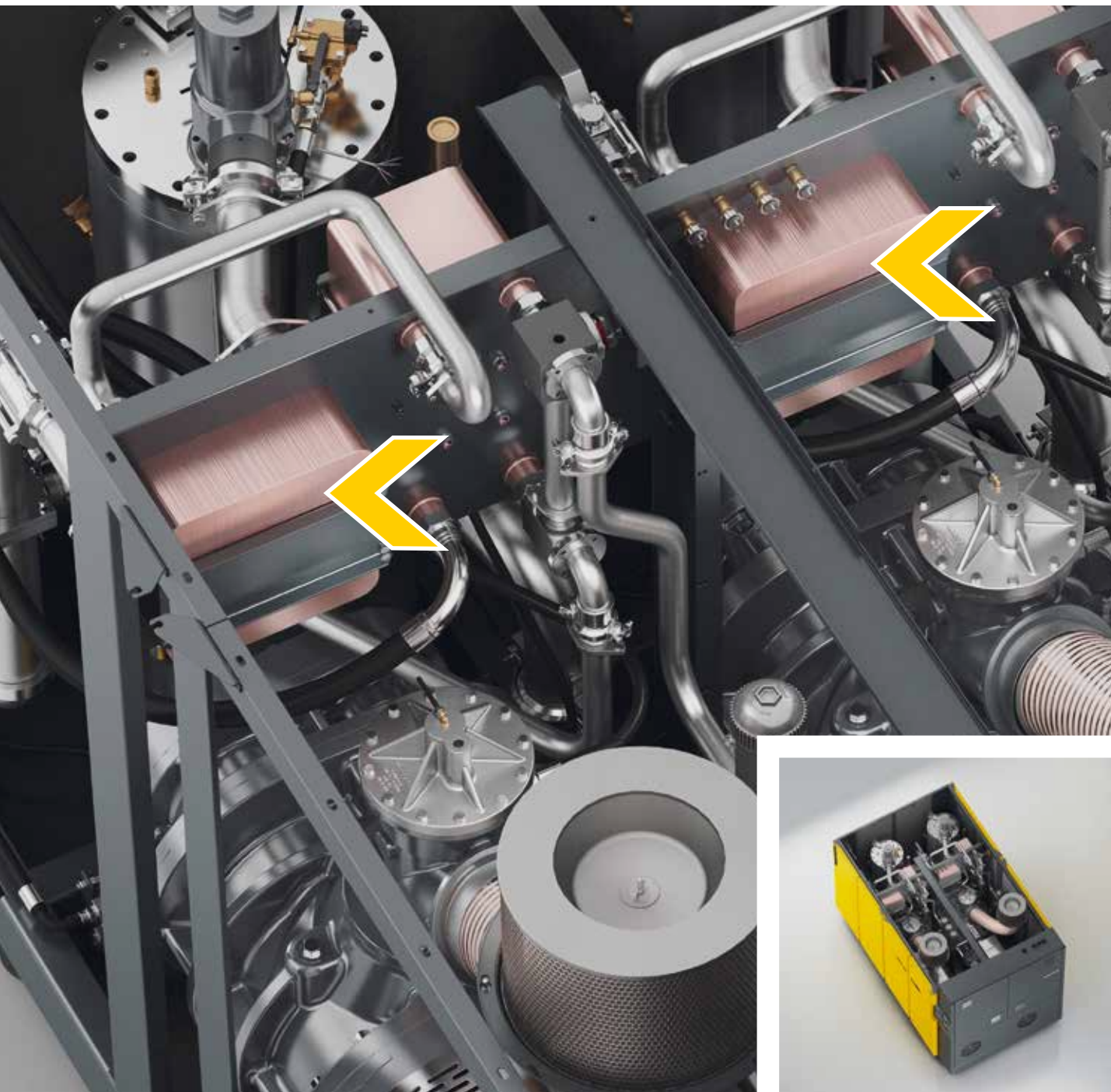

Two copper plate-soldered stainless-steel plate-type heat exchangers assure excellent heat transmission thanks to high cooling capacity plate corrugation design – the perfect choice for applications with clean compressor cooling water.

...with shell and tube heat exchanger

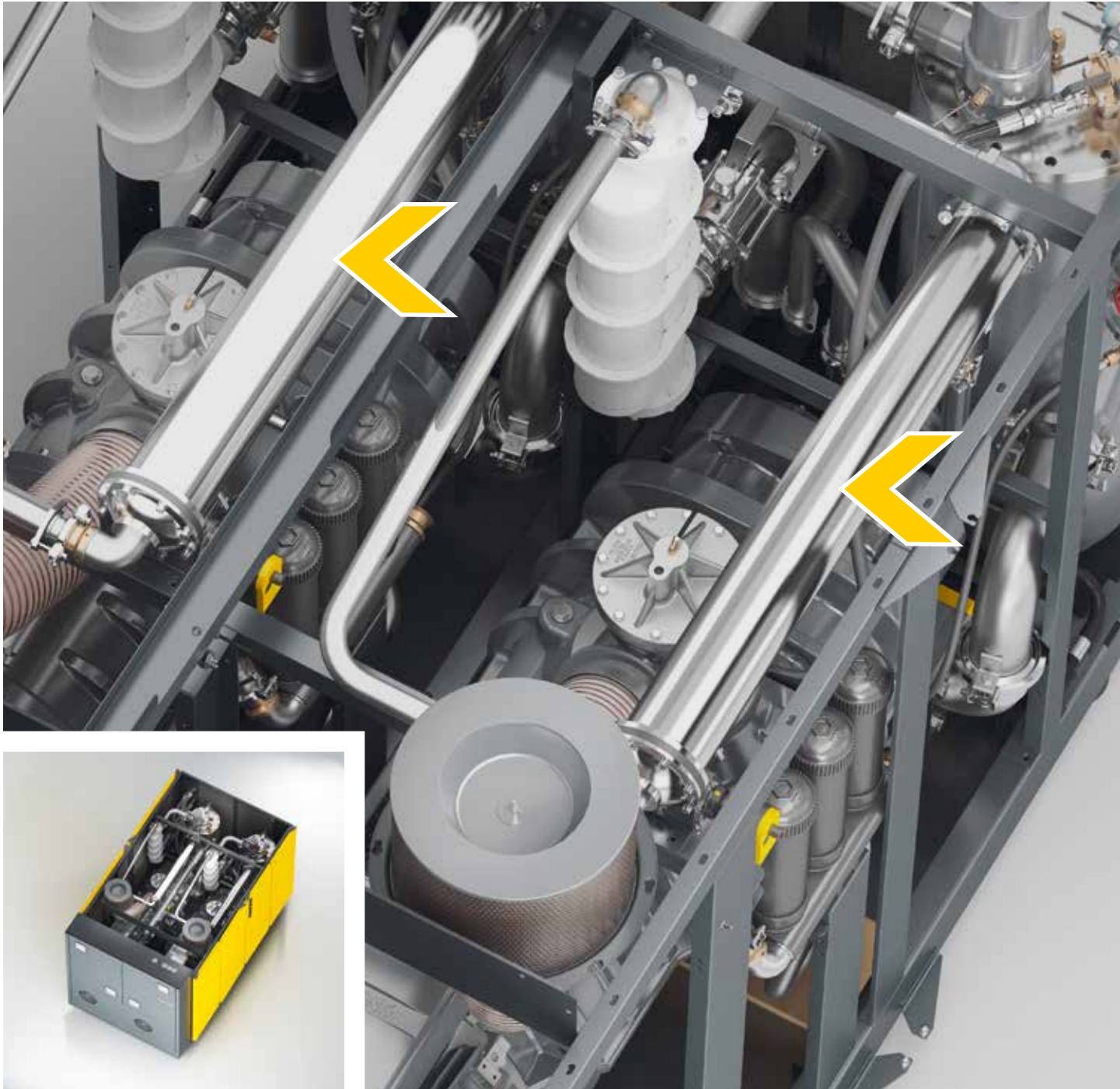

In comparison to plate heat exchangers of adequate cooling capacity, shell and tube heat exchangers made from copper-nickel alloy (CuNi10Fe) are less susceptible to contamination than plate heat exchangers. They are also more robust and the lines and exchangeable inserts can be cleaned very easily. In addition they are seawater-proof, which means that they are suitable for compressors used in shipping operations and operate with minimal pressure loss.



Heat exchanger (Internal)

Water-cooled rotary screw compressor



Hot water heating

Up to
96%
 usable for heating

Heat recovery an all-round win

Amazingly, 100 % of the electrical drive energy input to a compressor is converted into heat energy. Of that heat, up to 96 % is available for heat recovery purposes. Use this potential to your advantage!

Up to
+70 °C
 hot

Process, heating and service water

Hot water, up to 70 °C, can be produced from reusable compressor heat via PTG heat exchanger systems. Please contact KAESER regarding higher temperature requirements.

Heat recovery

Heating

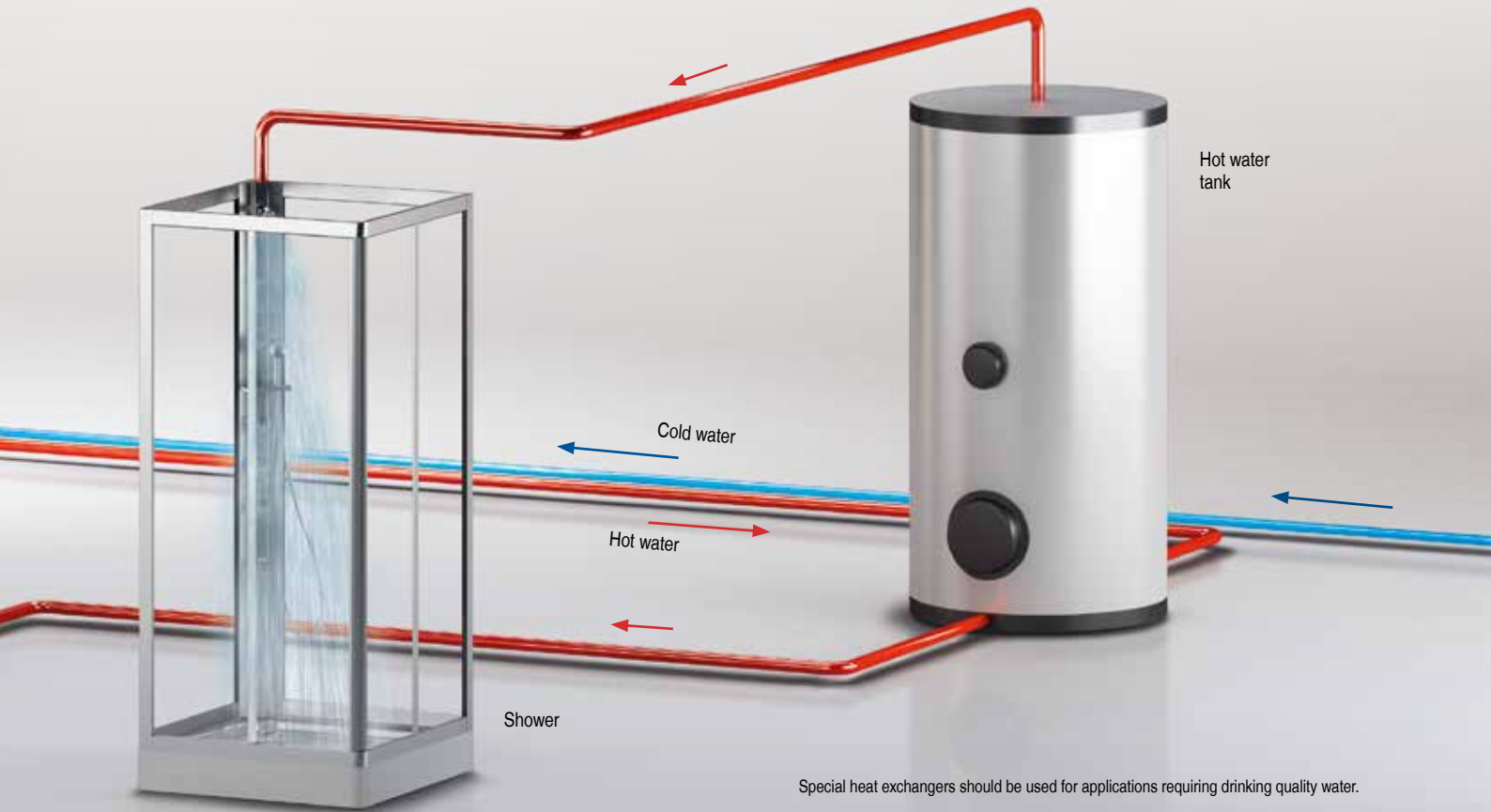

Systems for hot water usage

The integrated system comprising the heat exchanger, thermostatic valve and complete pipework requires no additional space in the compressor and can recover 76 % of the overall power consumption of HSD compressors by utilising the heat in the water.



Clean hot water

If no other water circuit is interconnected, special fail-safe SWT heat exchangers meet the highest demands for the purity of the water being heated, as required for cleaning water in the food industry, for example.



Heat recovery with the HSD series

Energy-saving, versatile and flexible



Dual Thermo Management

HSD packages with integrated heat recovery are equipped with two electromotive temperature control valves (Electronic Thermo Management, ETM) in each fluid circuit, one for the heat recovery system and one for the package oil cooler. This allows the SIGMA CONTROL 2 controllers to regulate compressor temperature as required for optimal heat recovery utilisation.



Flexible temperature

The SIGMA CONTROL 2 controller enables precision setting of the required airdend discharge temperature of the compressed air needed in order to achieve the desired water discharge temperature from the heat recovery system.



Winter ON – Summer OFF

If no heat recovery is required in the summer, it can be simply deactivated using the SIGMA CONTROL 2: under ETM control, the package starts to operate once again at maximum energy efficiency with lowest possible airdend temperature.

Equipment

Complete unit

Ready for operation, fully automatic, silenced, vibration damped, all panels powder coated. Can be used in ambient temperatures up to +45 °C. Service-friendly design: bearings for drive and fan motors can be lubricated externally.

Airend

Genuine KAESER single-stage rotary screw airend with energy-saving SIGMA PROFILE rotors and cooling-fluid injection for optimised rotor cooling. 1:1 direct drive.

Fluid and air flow

Dry air filter with pre-separation, inlet silencer, pneumatic inlet and venting valve, cooling fluid reservoir with three-stage separation system; safety valve, minimum pressure check valve, Electronic Thermo Management (ETM) and eco fluid filter in cooling circuit, fluid and compressed air cooler; two fan motors; KAESER centrifugal separator with electronically controlled condensate drain (high efficiency and zero pressure loss); stainless steel pipework and centrifugal separator.

Heat exchange

Fluid and compressed air aftercooler implemented as water-cooled plate type heat exchanger, or optionally available tube-type heat exchanger.

Optimised separator system

The combination of flow-optimised pre-separation and special separator cartridges results in minimal remaining fluid content of < 2 mg/m³ in the compressed air. This separator system requires less maintenance.

Heat recovery (Option)

Optionally available with integrated fluid-water plate-type heat exchanger and equipped with additional thermostatic valve for fluid; exterior connections.

Electrical components

Super Premium Efficiency IE4 drive motor with three Pt-100 winding temperature sensors for motor monitoring, IP 54 control cabinet, automatic star-delta protection combination, overload relay and control transformer. Frequency converter for drive motor with SFC version.

SIGMA CONTROL 2

“Traffic light” style LED indicators show operational status at a glance, plain text display, 30 selectable languages, soft-touch keys with icons, fully automated monitoring and control. Selection of Dual, Quadro, Vario, Dynamic and continuous control as standard. Interfaces: Ethernet; additional optional communication modules for: Profibus DP, Modbus, Profinet and Devicenet. SD-card slot for data-logging and updates; RFID reader, web server.

Efficient Dynamic control

The Dynamic control feature calculates run-on times based on the motor winding temperature. This reduces idling times and energy consumption. The SIGMA CONTROL 2 offers additional control modes as required.

SIGMA AIR MANAGER 4.0

The further-refined adaptive 3-D^{advanced} Control predictively calculates and compares various operating scenarios and selects the most efficient to suit the compressed air application's specific needs.

The SIGMA AIR MANAGER 4.0 therefore optimally adjusts flow rates and compressor energy consumption automatically in response to actual compressed air demand. This powerful feature is made possible by its industrial PC with multi-core processor in combination with the adaptive 3-D^{advanced} Control. Furthermore, the SIGMA NETWORK bus converters (SBC) provide a host of possibilities to enable the system to be individually tailored to meet exact user requirements. The SBC can be equipped with digital and analogue input and output modules, as well as with SIGMA NETWORK ports, to enable seamless display of flow rate, pressure dew point, power or alarm message information.

Amongst other key features, the SIGMA AIR MANAGER 4.0 provides long-term data storage capability for reporting, controlling and audits, as well as for energy management tasks as per ISO 50001.

(See image to the right; excerpt from the SIGMA AIR MANAGER 4.0 brochure)



Digital output device, e.g. laptop



Control centre

KAESER CONNECT

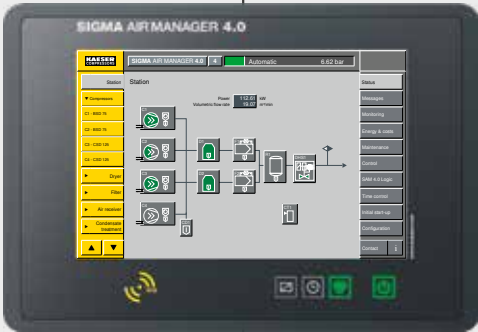

SIGMA AIR MANAGER 4.0

Communications module e.g. Modbus TCP

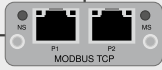

KAESER SIGMA NETWORK

SIGMA NETWORK
PROFIBUS Master

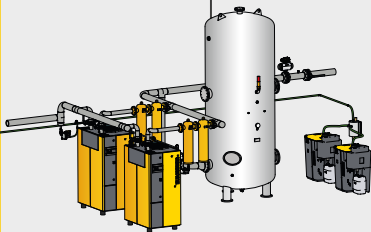

Various connection possibilities
for treatment components

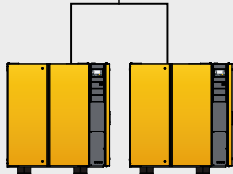

Connection of conventional
compressors possible



Controller:
SIGMA CONTROL 2

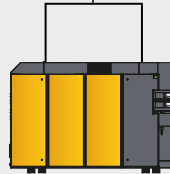

Connection of compressors with
SIGMA CONTROL 2



Controller:
SIGMA CONTROL

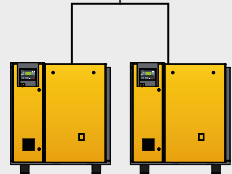

Connection of compressors with SIGMA CONTROL;
connection to stations with Profibus network (replacement
for SIGMA AIR MANAGER 1)



Secure data – secure business!

Technical specifications

Standard version

Model	Working pressure	Flow rate *) overall machine at operating pressure	Max. operating pressure	Drive motor rated power	Dimensions W x D x H	Compressed air connection	Sound pressure level **)	Mass
	bar							
HSD 662	7.5	66.40	8.5	360	3570 x 2145 x 2350	DN 150 PN 16	71	8100
	10	54.44	12					
	13	43.72	15					
HSD 722	7.5	72.40	8.5	400	3570 x 2145 x 2350	DN 150 PN 16	72	8500
	10	59.48	12					
	13	47.87	15					
HSD 782	7.5	78.40	8.5	450	3570 x 2145 x 2350	DN 150 PN 16	72	8600
	10	65.31	12					
	13	53.07	15					
HSD 842	7.5	84.40	8.5	500	3570 x 2145 x 2350	DN 150 PN 16	73	8700
	10	71.15	12					
	13	58.27	15					

SFC - Version with variable speed drive

Model	Working pressure	Flow rate *) overall machine at operating pressure	Max. operating pressure	Drive motor rated power	Dimensions W x D x H	Compressed air connection	Sound pressure level **)	Mass
	bar							
HSD 662 SFC	7.5	10.40 - 66.35	8.5	382	4370 x 2145 x 2350	DN 150 PN 16	73	9100
	10	8.50 - 57.50	12					
HSD 782 SFC	7.5	11.90 - 77.80	8.5	410	4370 x 2145 x 2350	DN 150 PN 16	74	9600
	10	10.00 - 65.50	12					
	13	8.00 - 55.78	15					
HSD 842 SFC	7.5	11.90 - 87.30	8.5	515	4370 x 2145 x 2350	DN 150 PN 16	75	10100
	10	10.00 - 74.44	12					
	13	8.00 - 63.44	15					

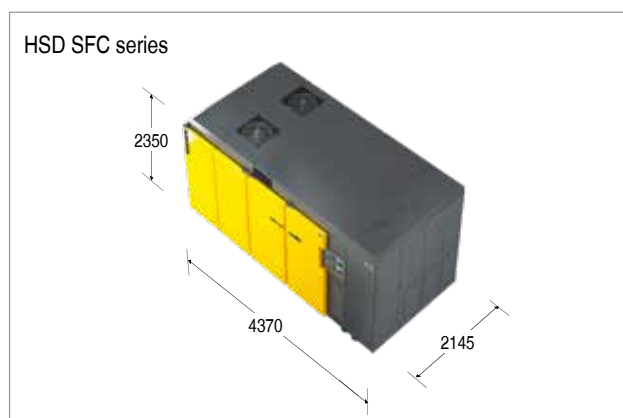
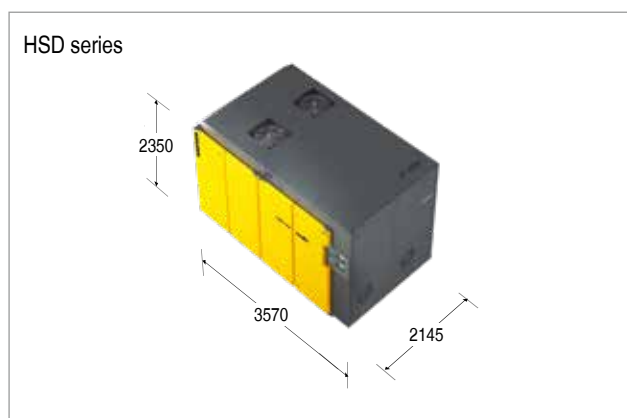

*) Flow rate complete system as per ISO 1217: 2009 Annex C/E: absolute inlet pressure 1 bar (a), cooling and air inlet temperature +20 °C

**) Sound pressure level as per ISO 2151 and basic standard ISO 9614-2, tolerance: ± 3 dB (A)

How it works

Standard version with plate-type heat exchanger

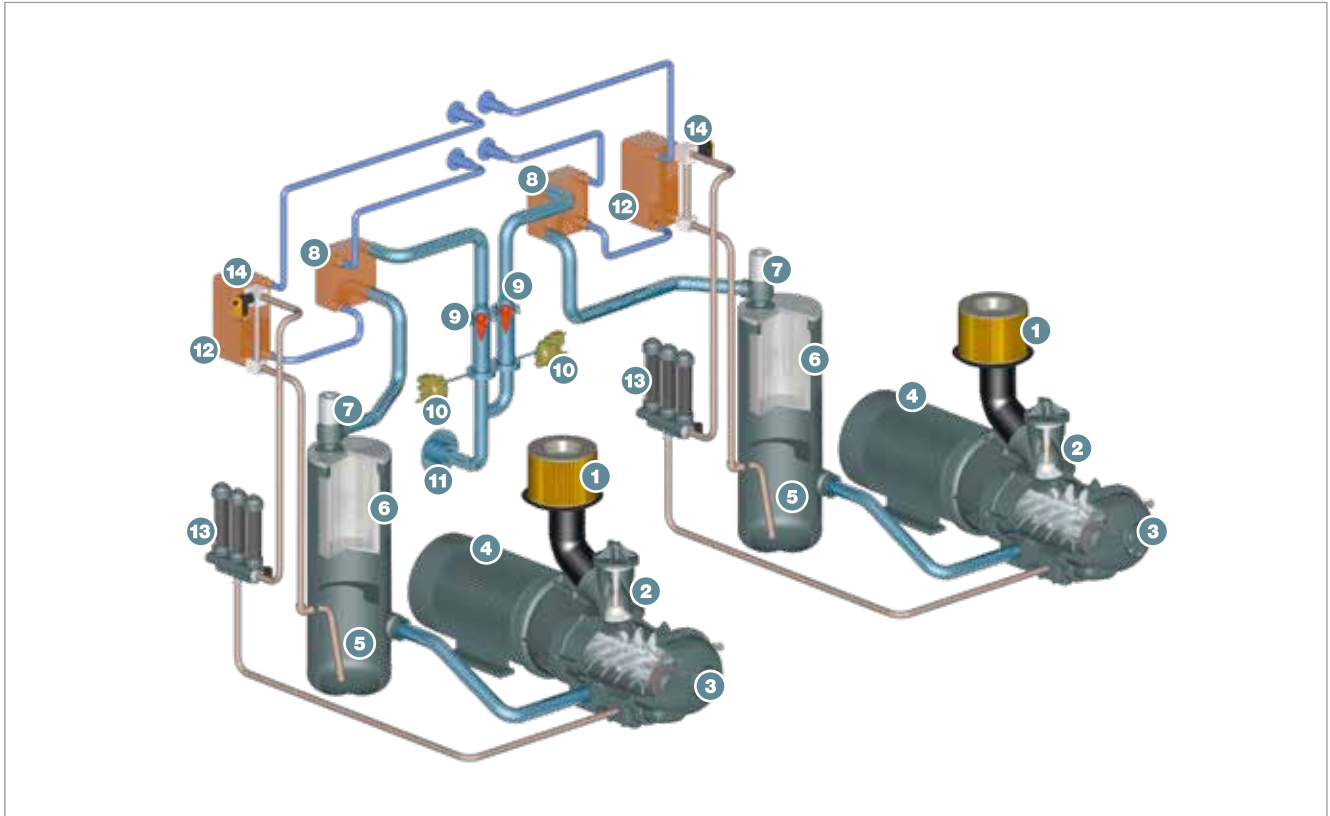

The air to be compressed passes through the intake filter (1) and the inlet valve (2) into the SIGMA PROFILE compressor air end (3). The compressor air end (3) is driven by a high efficiency electric motor (4). The cooling oil injected for cooling purposes during the compression process is re-separated from the air in the fluid separator tank (5). The compressed air flows through the 2-stage fluid separator cartridge (6) and the minimum pressure check valve (MDRV) (7) into the compressed air aftercooler (8). After cooling, any accumulating condensate is removed from the compressed air by the integrated centrifugal separator (9) and is then drained away from the machine via the installed ECO-DRAIN condensate drain (10). The condensate-free compressed air then leaves the system at the compressed air connection (11). The heat generated during the compression process is then removed from the cooling oil via the fluid cooler (12) with water heat exchanger. The cooling oil is then cleaned by the ECO fluid filter (13). The Electronic Thermo Management (ETM) system (14) ensures lowest possible operating temperatures. The control cabinet houses the internal SIGMA CONTROL 2 compressor controller and, depending on the design, the star-delta starters or the frequency converter (SFC).

- (1) Intake filter
- (2) Inlet valve
- (3) SIGMA PROFILE air end
- (4) IE4 drive motor
- (5) Fluid separator tank
- (6) Fluid separator cartridge
- (7) Minimum pressure check valve
- (8) Compressed air aftercooler
- (9) Centrifugal separator
- (10) Condensate drain (ECO-DRAIN)
- (11) Compressed air connection
- (12) Fluid cooler
- (13) ECO fluid filter
- (14) Electronic Thermo Management (ETM)

The world is our home

As one of the world's largest compressed air system providers and compressor manufacturers, KAESER KOMPRESSOREN is represented throughout the world by a comprehensive network of branches, subsidiary companies and authorised partners in over 100 countries.

With innovative products and services, KAESER KOMPRESSOREN's experienced consultants and engineers help customers to enhance their competitive edge by working in close partnership to develop progressive system concepts that continuously push the boundaries of performance and compressed air efficiency.

Moreover, the decades of knowledge and expertise from this industry-leading system provider are made available to each and every customer via the KAESER group's global computer network.

These advantages, coupled with KAESER's worldwide service organisation, ensure that every product operates at the peak of its performance at all times and provides maximum availability.



EMINENT POWER ENGINEERING PVT LTD
Regd. Office : 871/B1/D, GIDC Industrial Estate,
Near Himalaya Char Rasta, Makarpura, Vadodara-390 010.
Ph : +91 9824459599, Email : info@eminentpowerepl.com,
Website : www.eminentpowerepl.com